

SPECIFICATIONS	
TYPE	Bolt-on seat with upholstery plate
SEAT DEPTH ADJUSTMENT	<ul style="list-style-type: none"> <li>– Fixed</li> <li>– 100,0 mm [3.94 in], by lever</li> </ul>
CERTIFICATIONS	<ul style="list-style-type: none"> <li>– EN1335</li> <li>– BIFMA</li> </ul>
UPHOLSTERY FIXING	By traditional upholstery plate (4 clips)
ARMREST CONNECTION	Type-B armrest interface (external armband)
MECHANISM CONNECTION	<ul style="list-style-type: none"> <li>– Donati universal seat plate</li> <li>– Bolt-on plate 153 x 200 mm [6.02 x 7.87 in]</li> <li>– Bolt-on plate 200 x 200 mm [7.87 x 7.87 in]</li> </ul>
ITEMS PER BOX	40
BOXES PER PALLET	4 boxes (160 items)
PALLET SIZE (LxWxH)	80 x 120 x 170 cm [31.5 x 47.2 x 66.9 in]

## PRODUCT CODES

.....	
<u>FLAT</u>	
FIXED	4515200
SLIDING (FIXING HOLES 153 x 200 mm)	4515201
SLIDING (FIXING HOLES 200 x 200 mm)	4515204
<u>UPHOLSTERY PLATE</u>	4515202

TECHNICAL DRAWING

FLAT SLIDING - CONNECTION 153 x 200 / 200 x 200 mm

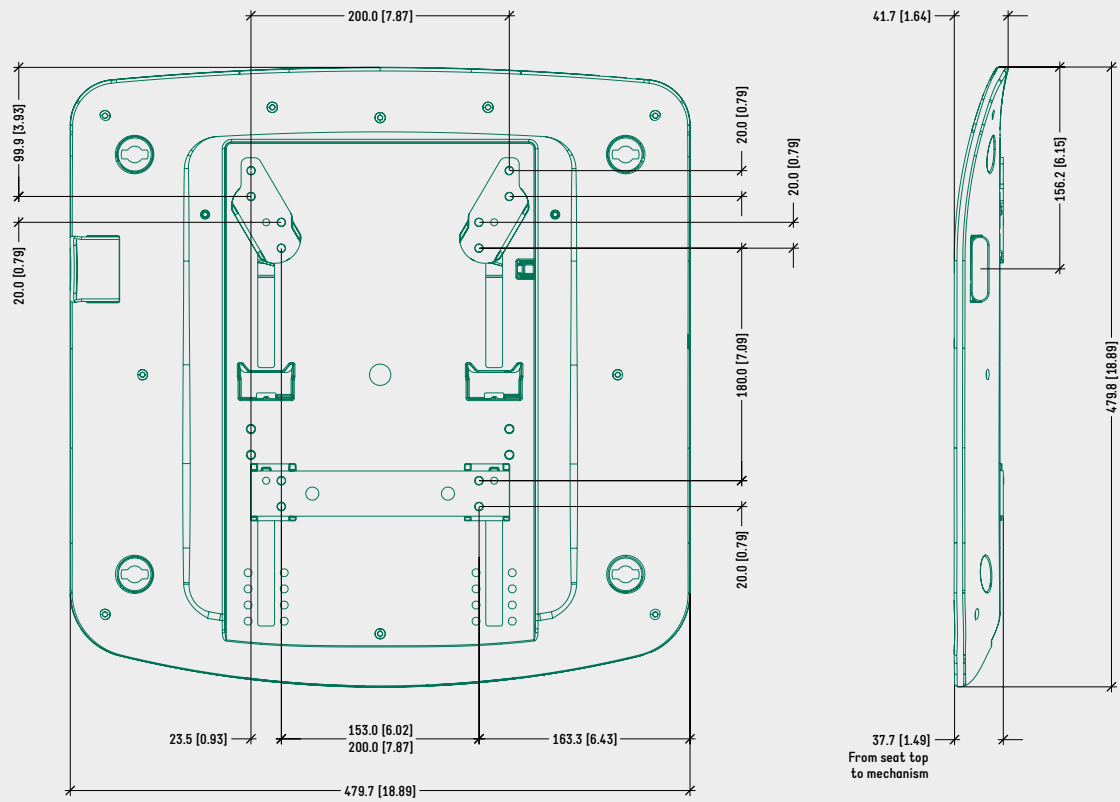

SURFACE COLOURS / FINISHES



PHOTOENGRAVED  
[NOVATEX 7381]  
SEAT

TYPE-B ARMREST FIXING KIT CODES

FOR ALUMINIUM ARMREST

WIDTH ADJUSTABLE - WITH ARMBAR 4500118

WIDTH ADJUSTABLE - W/O ARMBAR 4500165

FOR NYLON ARMREST

WIDTH ADJUSTABLE - WITH ARMBAR 4500162

WIDTH ADJUSTABLE - W/O ARMBAR 4500164

RELATED PRODUCTS

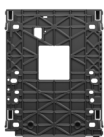

DONATI UNIVERSAL  
SEAT PLATE CONNECTION  
MECHANISMS

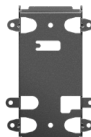

DONATI BOLT-ON  
SEAT PLATE MECHANISMS



TYPE-B ARMREST  
INTERFACE CONNECTION  
ONLY

TECHNICAL DRAWING

FLAT FIXED

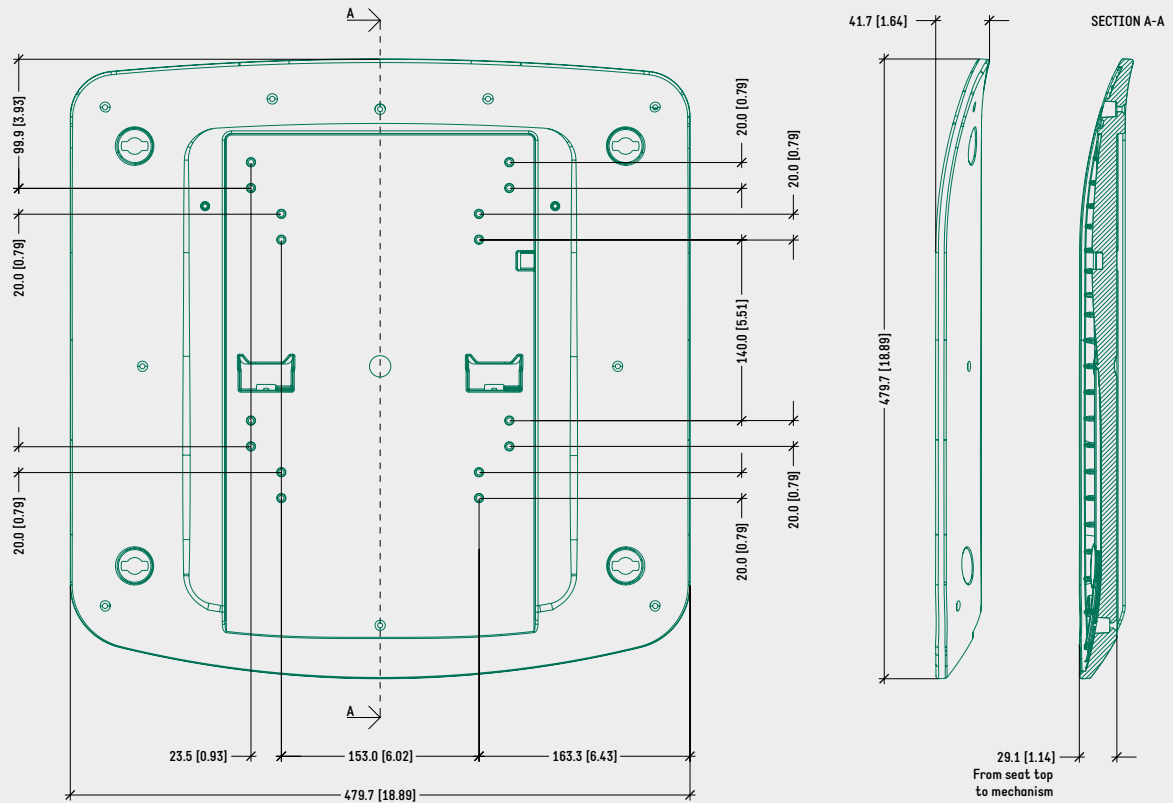

SURFACE COLOURS / FINISHES



PHOTOENGRAVED  
[NOVATEX 7381]  
SEAT

TYPE-B ARMREST FIXING KIT CODES

FOR ALUMINIUM ARMREST

- WIDTH ADJUSTABLE - WITH ARMBAR 4500118
- WIDTH ADJUSTABLE - W/O ARMBAR 4500165

FOR NYLON ARMREST

- WIDTH ADJUSTABLE - WITH ARMBAR 4500162
- WIDTH ADJUSTABLE - W/O ARMBAR 4500164

RELATED PRODUCTS

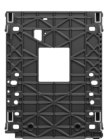

DONATI UNIVERSAL  
SEAT PLATE CONNECTION  
MECHANISMS

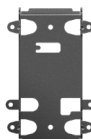

DONATI BOLT-ON  
SEAT PLATE MECHANISMS



TYPE-B ARMREST  
INTERFACE CONNECTION  
ONLY

TECHNICAL DRAWING

UPHOLSTERY PLATE

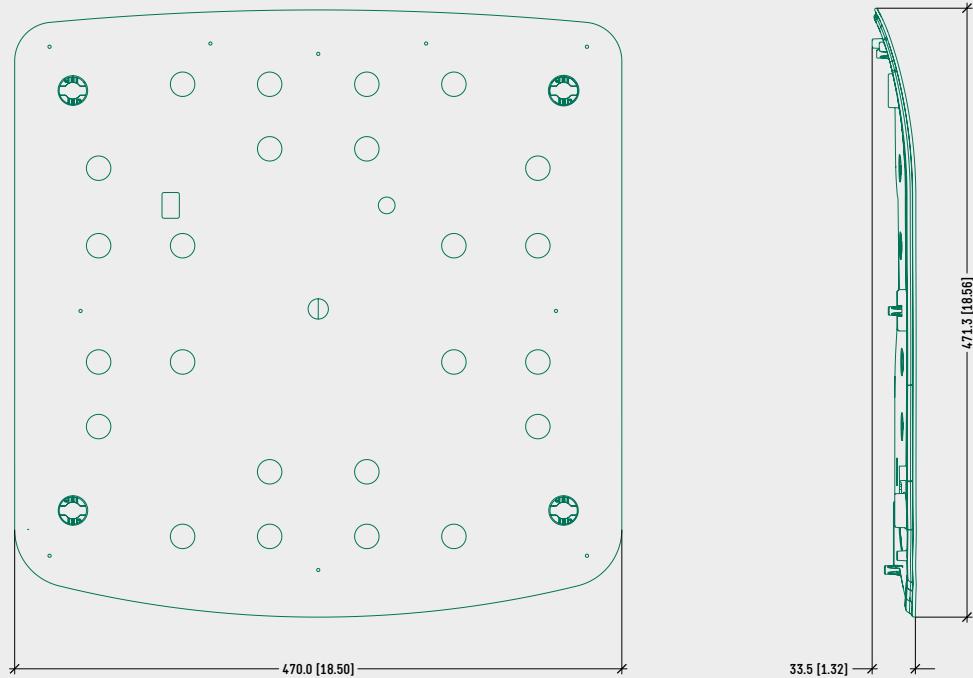

SURFACE COLOURS / FINISHES



BLACK PLASTIC  
UPHOLSTERY PLATE